



ESBE System Units
CIRCULATION UNIT DN25, DN32



Mtrl.nr: 98141083 • Ritn.nr: 7879 vers. B • Rev. 2021-10-21



Series GDA200
Series GRA200

Series GFC200
Series GBA200

LVD 2014/35/EU
EMC 2014/30/EU
RoHS 2011/65/EU
PED 2014/68/EU, article 4.3

ErP 2009/125/EU
ErP 2015
EnEV 2014
CE EAC UK CA

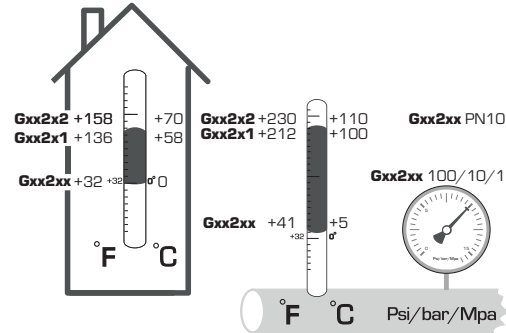

SERIES	FUNCTION
ESBE GDA211 GDA 212	
ESBE GFA211 GFA212	
GRA211 GRA212 GRA231 GRA232	
GRC221 GRC222 GRC241 GRC242	
ESBE GBA211	



Cabling • Dimensions

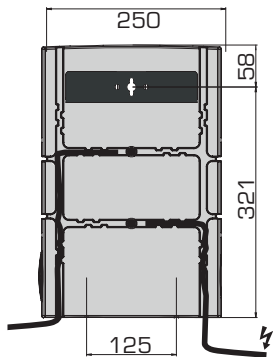

Mounting position

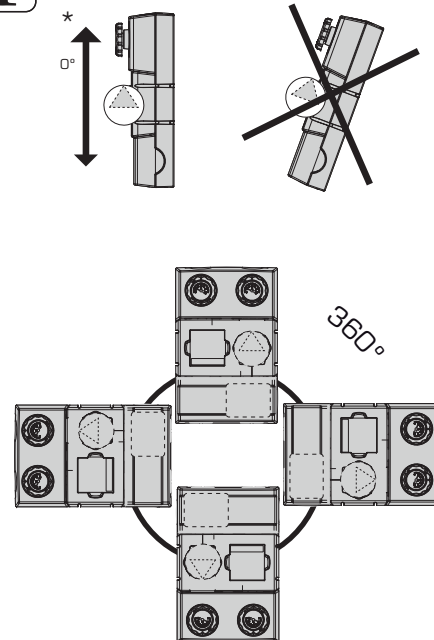

Remove actuator

Series GRA2xx, GBA211, GRC2xx

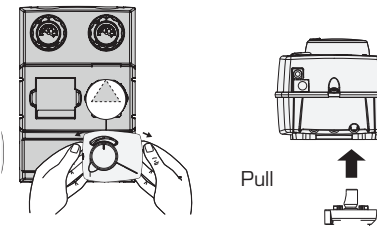

Disassembly insulation

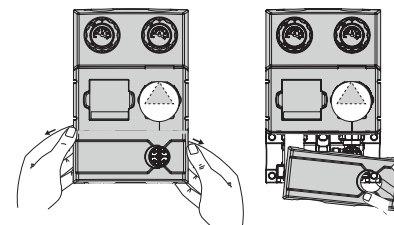

Fit supply pipes

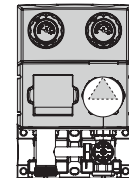

Assemble on manifold

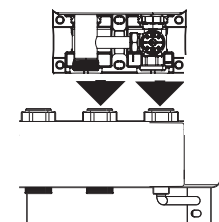

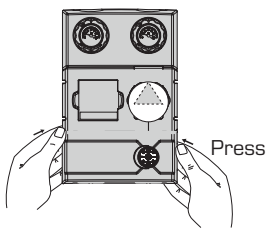
3**Assemble lower insulation****Assemble actuator**

Series GRA2xx, GBA211, GRC2xx

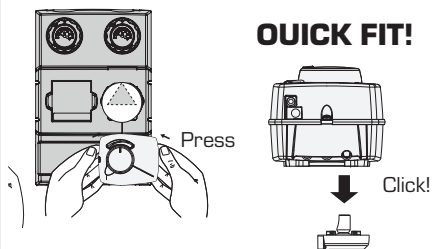
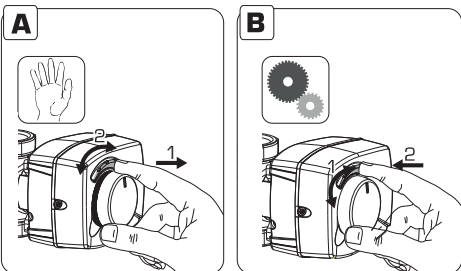
**i****Commissioning actuator:**

<https://esbe.eu/group/products/rotary-actuators>

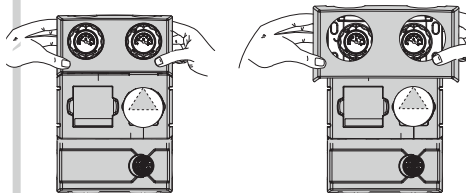
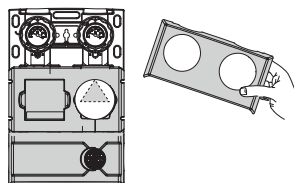
4**Pull up insulation****Remove****i****Commissioning fixed temperature**

Series GFA211, GFA212

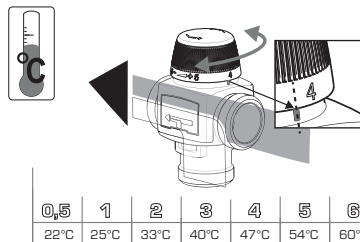

<https://esbe.eu/group/products/thermostatic-mixing-valves>

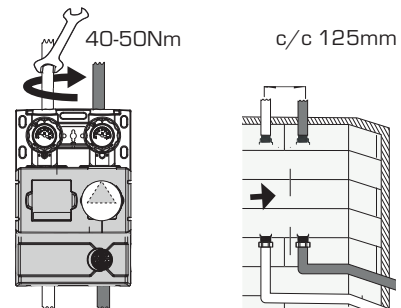
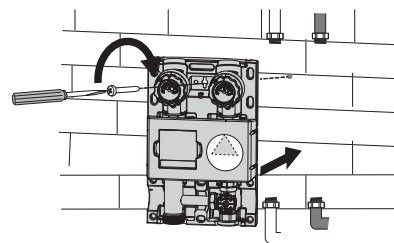
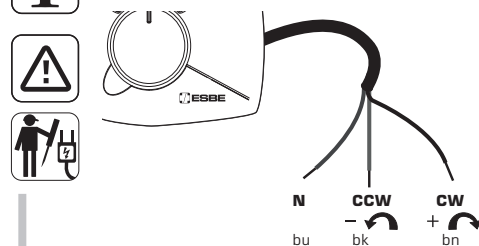
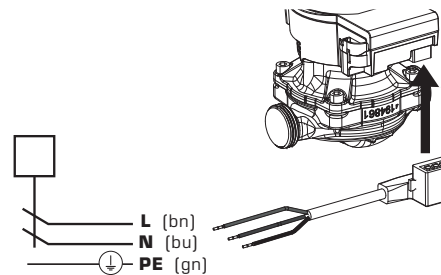
5**Assembling on wall without manifold****i****Electric installation****Power**

i www.esbe.eu

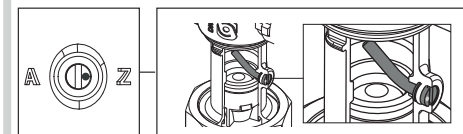
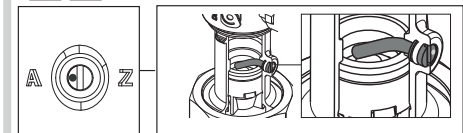
i**Commissioning****1** **Filling and venting****2**



Wilo Display

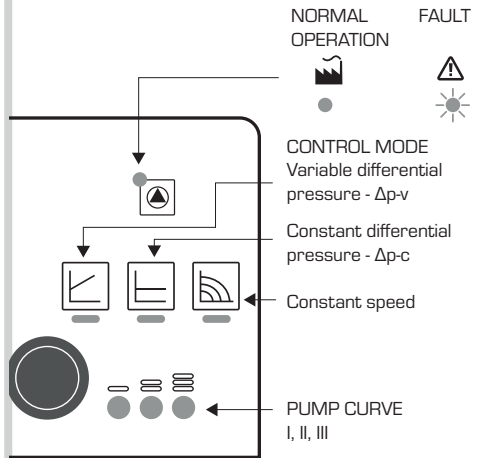

7

Pump Settings

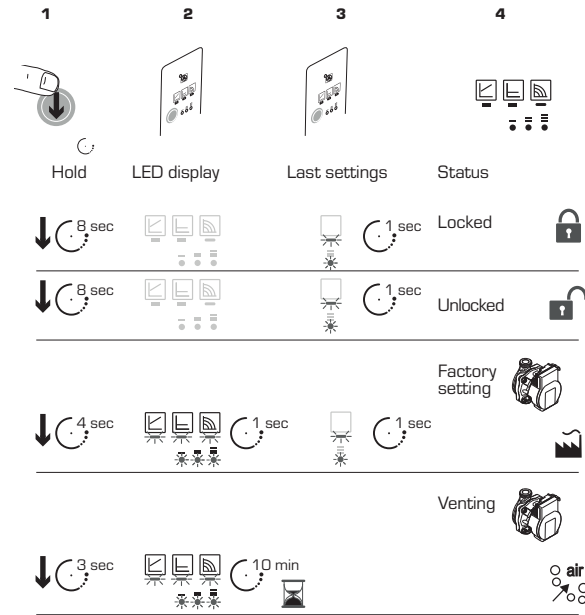

Settings navigations

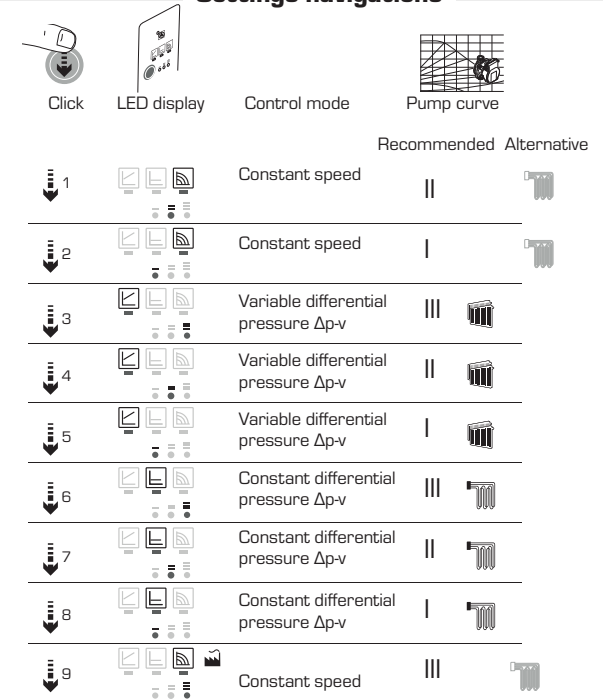

WILO - Faults, Causes and Remedies

LED Indicator	Meaning	Diagnostic	Cause	Remedy
lights green	Pump in operation	Pump runs according its setting	Normal operation	
lights orange	Pump is in PWM mode	Pump is speed controlled by the PWM signal	Normal operation	
blinks red/green	Pump in function but stopped	Pump restarts by itself after the fault is disappeared	1. Undervoltage $U < 160 V$ or Overvoltage $U > 253 V$ 2. Modul overheating: temperatur inside motor too high	1. Check voltage supply $195 V < U < 253 V$ 2. Check water and ambient temperature
blinks red	Pump out of function	Pump stopped (blocked)	Pump does not restart by itself due to a permanent failure	Change pump
blinks orange	Pump out of function	Pump stopped	Pump is not starting	Change pump
LED off	No power supply	No voltage on electronics	1. Pump is not connected to power supply 2. LED is damaged 3. Electronics are damaged	1. Check cable connection to power supply 2. Check if pump is running 3. Change pump

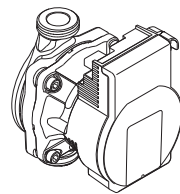

<http://www.esbe.eu/global/en/products/circulation units>



Factory setting



= Factory settings



Grundfos Display

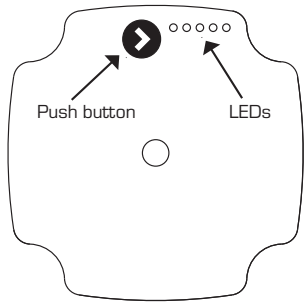

http://www.esbe.eu/global/en/products/circulation_units



Grundfos - Faults, Display and Solutions

FAULT

DISPLAY

SOLUTION

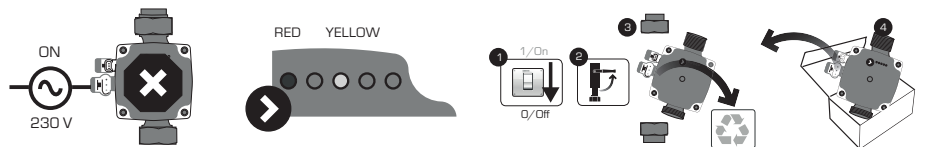
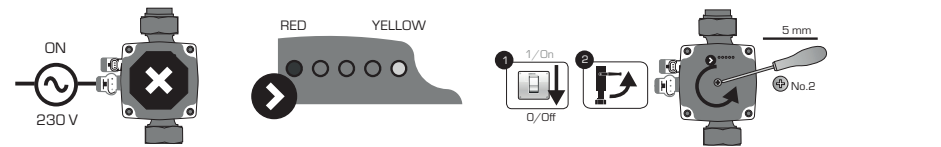
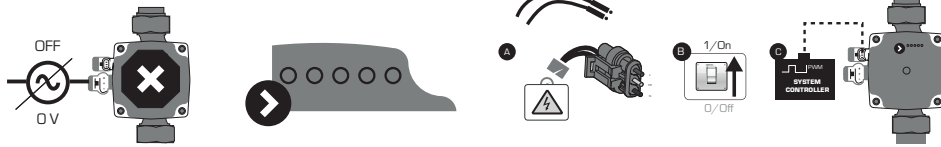

7

Settings navigation

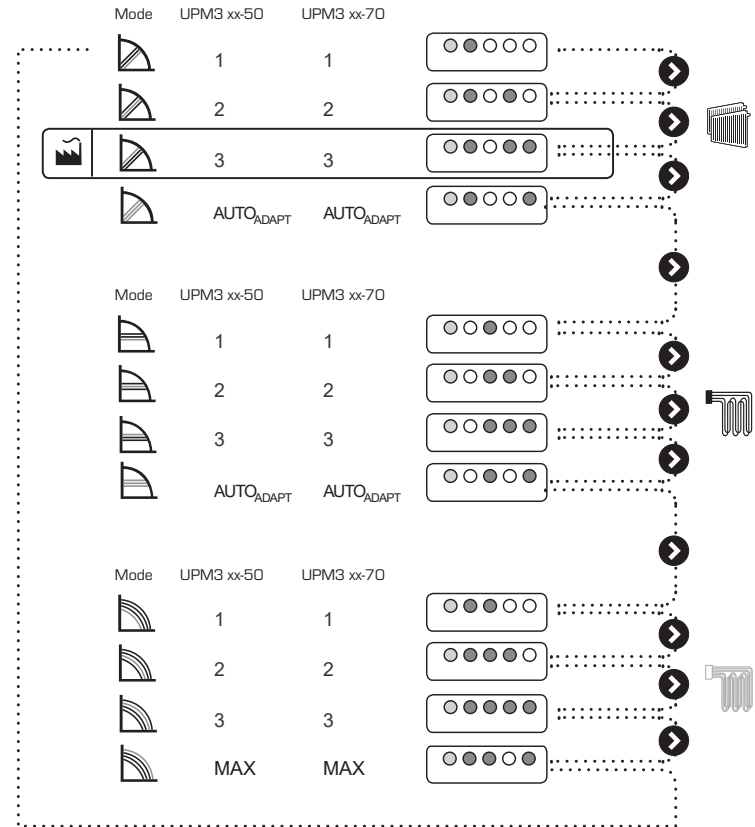
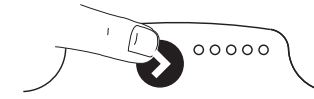

8

Expose application info using leaflet

