

MSL, MSV, SV Series

Safety valves

Technical Data Sheet



Description

MSL, MSV and SV Series safety valves automatically discharge enough liquid to ensure that the safety pressure setpoint is not exceeded. They protect the boiler and system, and require no energy except the pressurised fluid.

The valves are designed and manufactured in compliance with "R" regulations - 2009 edition, applied technical specifications of Italian Ministerial Decree 1-12-1975.

MSL



Diaphragm safety valve. **1/2" MF connections.**

CW617N brass body. Technopolymer manual discharge knob.

Ni-Cr steel spring.

Fluids: water with glycol \leq 50%.

Operating temperature: -10 to 110°C.

WRAS compliant.

Compliant with PED 2014/68/EU Identification number CE0425.

Type	Part No.	DN	bar	Weight (g)
MSL	0206015N	1/2"	1,5	150
MSL	0206018N	1/2"	1,8	150
MSL	0206020N	1/2"	2	150
MSL	0206525	1/2"	2,5	150
MSL	0206530	1/2"	3	150
MSL	0206035N	1/2"	3,5	150
MSL	0206540	1/2"	4	150
MSL	0206050N	1/2"	5	150
MSL	0206060N	1/2"	6	150
MSL	0206070N	1/2"	7	150
MSL	0206080N	1/2"	8	150
MSL	0206090N	1/2"	9	150
MSL	0206099N	1/2"	10	150

MSV



Diaphragm safety valve. **1/2" FF connections.**

CW671N brass body. Technopolymer manual discharge knob.

Ni-Cr steel spring.

Fluids: water with glycol \leq 50%.

Operating temperature: -10 to 110°C.

WRAS compliant.

Compliant with PED 2014/68/EU Identification number CE0425.

Type	Part No.	DN	bar	Weight (g)
MSV	0207015N	1/2"	1,5	150
MSV	0207018N	1/2"	1,8	150
MSV	0207020N	1/2"	2	150
MSV	0207525	1/2"	2,5	150
MSV	0207530	1/2"	3	150
MSV	0207035N	1/2"	3,5	150
MSV	0207540	1/2"	4	150
MSV	0207050N	1/2"	5	150
MSV	0207060N	1/2"	6	150
MSV	0207070N	1/2"	7	150
MSV	0207080N	1/2"	8	150
MSV	0207090N	1/2"	9	150
MSV	0207099N	1/2"	10	150

SV



Diaphragm safety valve. CW617N brass body.
Technopolymer manual discharge knob. Ni-Cr steel spring.
Rubber diaphragm and seal resistant to 110°C.
FF connections with larger outlet.

TÜV approved.

Compliant with PED 2014/68/EU Identification number CE0425.

Type	Part No.	DN	bar	Weight (g)
SV	0216015N	1/2" x 3/4"	1,5	200
SV	0216018N	1/2" x 3/4"	1,8	200
SV	0216020N	1/2" x 3/4"	2	200
SV	0215125	1/2" x 3/4"	2,5	200
SV	0215130	1/2" x 3/4"	3	200
SV	0216035N	1/2" x 3/4"	3,5	200
SV	0215104	1/2" x 3/4"	4	200
SV	0216045N	1/2" x 3/4"	4,5	200
SV	0216050N	1/2" x 3/4"	5	200
SV	0216055N	1/2" x 3/4"	5,5	200
SV	0216060N	1/2" x 3/4"	6	200
SV	0216070N	1/2" x 3/4"	7	200
SV	0216080N	1/2" x 3/4"	8	200
SV	0216090N	1/2" x 3/4"	9	200
SV	0216099N	1/2" x 3/4"	10	200
SV	0217015N	3/4" x 1"	1,5	270
SV	0217018N	3/4" x 1"	1,8	270
SV	0217020N	3/4" x 1"	2	270
SV	0217625	3/4" x 1"	2,5	270
SV	0217630	3/4" x 1"	3	270
SV	0217035N	3/4" x 1"	3,5	270
SV	0217604	3/4" x 1"	4	270
SV	0217045N	3/4" x 1"	4,5	270
SV	0217050N	3/4" x 1"	5	270
SV	0217055N	3/4" x 1"	5,5	270
SV	0217060N	3/4" x 1"	6	270
SV	0217070N	3/4" x 1"	7	270
SV	0217080N	3/4" x 1"	8	270
SV	0217090N	3/4" x 1"	9	270
SV	0217099N	3/4" x 1"	10	270
SV	0218615	1"x1.1/4"	1,5	660
SV	0218625	1"x1.1/4"	2,5	660
SV	0218630	1"x1.1/4"	3	660
SV	0218604	1"x1.1/4"	4	660
SV	0218305	1"x1.1/4"	5	660
SV	0218606	1"x1.1/4"	6	660
SV	0218607	1"x1.1/4"	7	660
SV	0218608	1"x1.1/4"	8	660
SV	0218610	1"x1.1/4"	10	660
SV	0219615	1.1/4"x1.1/2"	1,5	860
SV	0219625	1.1/4"x1.1/2"	2,5	860
SV	0219630	1.1/4"x1.1/2"	3	860
SV	0219604	1.1/4"x1.1/2"	4	860
SV	0219405	1.1/4"x1.1/2"	5	860
SV	0219606	1.1/4"x1.1/2"	6	860
SV	0219607	1.1/4"x1.1/2"	7	860
SV	0219608	1.1/4"x1.1/2"	8	860
SV	0219610	1.1/4"x1.1/2"	10	860

IS



Exposed drain funnel for safety and thermal drain valves.

Type	Part No.	DN	Weight (g)
IS	0235115	1/2" FF	270
IS	0235120	3/4" FF	400
IS	0235125	1" FF	600
IS	0235132	1.1/4" FF	1000

Technical features	
Nominal pressure	PN10
Overpressure	<10%
Blowdown	<15% (MSL, MSV) <20% (SV)
Operating temperature	-10 to 110°C
PED class	IV

Materials	
Body	CW617N brass
Diaphragm	EPDM
Manual discharge knob	technopolymer
Setting spring	Ni-Cr steel
Cap and disc	reinforced technopolymer

Certifications

CE mark

MSL, MSV and SV Series safety valves meet the requirements of the Pressure Equipment Directive 2014/68/EU. The valves are classified in category IV, considered the highest risk category, given that they are safety devices and bear the CE mark followed by the number 0425, identifying the approval authority.

See the individual model descriptions for other approvals (UDT, AFNOR, TÜV).

In accordance with EN1491, the maximum power of the boiler on the basis of the diameter is:

Size	1/2" = DN15	3/4" = DN20	1" = DN25	1.1/4" = DN32
Power	75kW	150kW	250kW	350kW
Max. Volume	200 l	1,000 l	5,000 l	> 5000

Application

MSL, MSV and SV Series safety valves are generally used in closed-loop heating systems with rated power of less than 35kW that use hot water at temperatures below 110°C, and in plumbing systems to protect hot water storage. The safety valve protects the generator or the storage tank from sudden, unexpected pressure surges.

Therefore, the safety valve remains inoperative when the system is operating normally.

Operation

The fluid in the system exerts pressure on the disc, which pushes against the spring until the pressure exceeds the declared setting. The disc then slowly starts to open, allowing the water flow to inflate the diaphragm.

The valve opens and discharges into the air, relieving the system from dangerous pressure for the boiler and system components.

The disc opens fully before the fluid pressure exceeds the pressure setpoint by 10% (**overpressure**).

The valve closes before the pressure drops to 15% less than the setpoint pressure (**blowdown**).

On **SV Series** valves, the outlet port has a wider diameter than the inlet port, increasing the discharge capacity of the valve.

The characteristics of the materials prevent the valves from seizing as a result of ageing.

MSV series

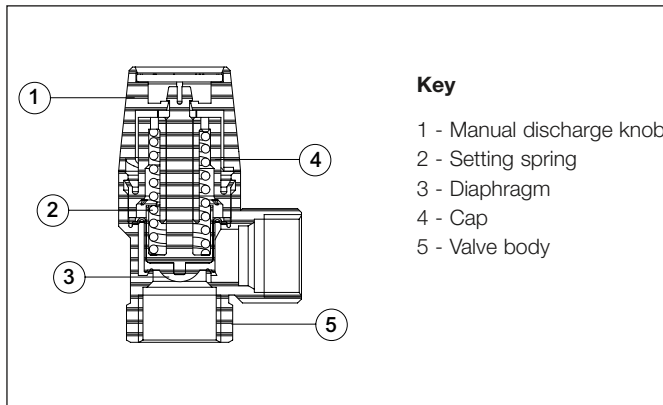

MSL series

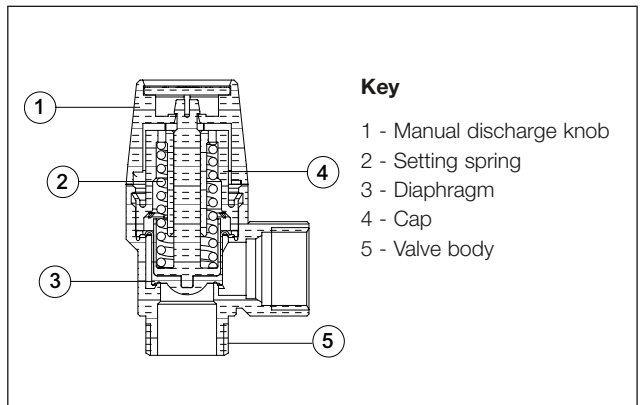

SV series

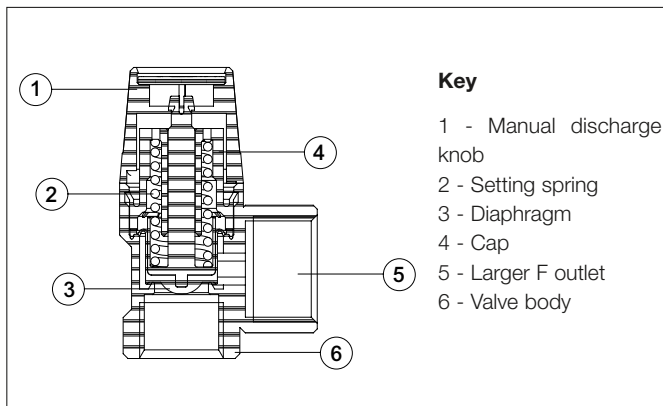

Sizing

Safety valves designed for use with **heating systems**, where no experimental determination is carried out are defined as standard valves. In the calculation formula for these valves, the value of 0.9K, i.e. equal to 0.05 (R.2.A) should be assumed. The regulations thus drastically reduce the application limit for standard safety valves in the heating field. However, systems with rated power of less than 35 kW (30,000 kcal/h) are not subject to the regulations covered by Italian Ministerial Decree 1.12.1975.

$$W = \frac{0.9 \times A \times K}{0.005 \times F}$$

where:

- A = net valve orifice section in cm²
- F = factor inferred from Table 2 in "R" Regulations (R.2.A.2.3)
- W = steam venting capacity in kg/h

For **plumbing systems**, "R" Regulations indicate the sizing criterion for safety valves to be used in protecting domestic boilers. The orifice of these safety valves should have a diameter (D), with a minimum of 15 mm, of no less than:

$$D_{min} = \sqrt{V/5}$$

where:

- D = net valve orifice diameter in mm
- V = volume of boiler in litres

These valves must be set to a pressure not exceeding the maximum permissible boiler pressure, and connected directly without shut-off devices.

	Setting pressure	Max. discharge pressure	Min. discharge pressure	Orifice diameter	Orifice section	Discharge coeff.	Discharge flow rate	Max. rated power of boiler	
	(bar)	(bar)	(bar)	(mm)	(cm ²)	(K)	(kg/h)	(kW)	(kcal/h)
MSL/MSV									
1/2"	1,5	1,65	1,35	13,50	1,43	0,57	97	56	48.500
	1,8	1,98	1,62				109	63	54.250
	2	2,2	1,8				117	68	58.250
	2,5	2,75	2,25				135	78	67.250
	3	3,3	2,7				153	89	76.250
	3,5	3,85	3,15				172	100	85.750
	4	4,4	3,6				191	111	95.000
	5	5,5	4,5				226	131	112.750
	6	6,6	5,4				262	152	130.750
	7	7,7	6,3				300	174	149.500
	8	8,8	7,2				342	198	170.250
	9	9,9	8,1	377	218	187.750			
	10	11	9	408	237	203.500			
SV									
1/2"X3/4"	1,5	1,65	1,35	13,50	1,43	0,57	97	56	48.500
	1,8	1,98	1,62				109	63	54.250
	2	2,2	1,8				117	68	58.250
	2,5	2,75	2,25				135	78	67.250
	3	3,3	2,7				153	89	76.250
	3,5	3,85	3,15				173	100	86.250
	4	4,4	3,6				191	111	95.000
	4,5	4,95	4,05				210	122	104.750
	5	5,5	4,5				226	131	112.750
	5,5	6,05	4,95				245	142	122.000
	6	6,6	5,4				262	152	130.750
	7	7,7	6,3				300	174	149.500
	8	8,8	7,2				342	198	170.250
		9	9,9				8,1	377	218
	10	11	9	408	237	203.500			
3/4"X1"	1,5	1,65	1,35	14,00	1,54	0,66	121	70	60.500
	1,8	1,98	1,62				135	79	67.500
	2	2,2	1,8				145	84	72.500
	2,5	2,75	2,25				168	97	83.750
	3	3,3	2,7				190	110	95.000
	3,5	3,85	3,15				215	125	107.250
	4	4,4	3,6				238	138	118.500
	4,5	4,95	4,05				261	152	130.250
	5	5,5	4,5				281	163	140.250
	5,5	6,05	4,95				305	177	152.000
	6	6,6	5,4				327	189	162.750
	7	7,7	6,3				373	216	186.250
	8	8,8	7,2	425	247	212.000			

1"X1.1/4"	1,5	1,7	1,4	20,5	3,3	0,84	330	192	164.750
	2,5	2,8	2,3				458	266	228.250
	3	3,3	2,7				520	301	259.250
	4	4,4	3,6				648	376	323.250
	5	5,5	4,5				768	445	382.750
	6	6,6	5,4				891	517	444.250
	7	7,7	6,3				1018	591	507.750
	8	8,8	7,2				1160	673	578.750
	10	11	9				1386	804	691.250
1.1/4"X1.1/2"	1,5	1,7	1,4	27,5	5,94	0,49	347	201	173.000
	2,5	2,8	2,3				481	279	239.750
	3	3,3	2,7				546	317	272.250
	4	4,4	3,6				680	395	339.250
	5	5,5	4,5				806	467	402.000
	6	6,6	5,4				936	543	466.500
	7	7,7	6,3				1069	620	533.250
	8	8,8	7,2				1218	707	607.500
	10	11	9				1455	844	725.750

Installation

MSL, MSV and SV Series safety valves must be installed in accordance with the flow direction indicated by the arrow on the valve body.

The valves may be mounted horizontally or vertically as long as the discharge funnel is not facing upwards and is positioned so that the discharge cannot cause damage to property or injury to people.

The factory setting pressure of the safety valves is non-adjustable. The setting is indicated on the tag at the top of the manual discharge knob.

The valve discharge pipe must be visible and routed to a funnel (see **IS Series**) or receptacle, and facilitate inspection in the event of opening.

It should not be possible to shut off the connecting pipework between the safety valve and the boiler, nor should the section of this pipework be at any point less than the safety valve inlet port section.

To ensure perfect efficiency, the safety valves require regular inspection.

Over time, foreign matter may build up close to the disc; therefore the valve seat should be flushed periodically (e.g. at the start of the heating season). It can be flushed through manual discharge of the valve by turning the knob in the direction of the arrows. Almost all leaks (dripping, incomplete closing) are caused by impurities lodged between the seat and disc; therefore, periodic inspection and flushing prevent these leaks and any ensuing problems.

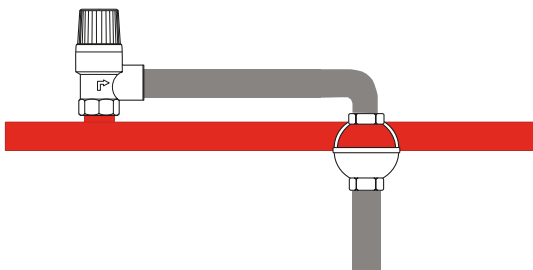

Fig.1
Direct installation of the funnel on the discharge pipework

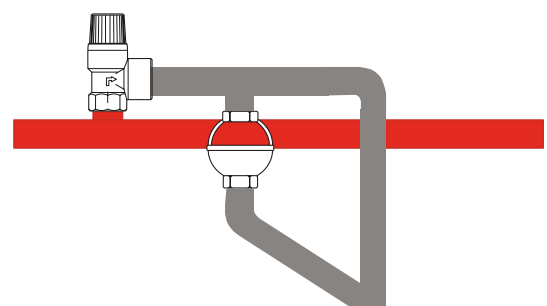
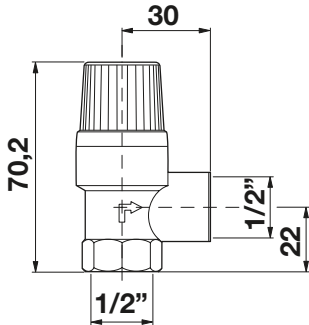

Fig.2
Common installation of the funnel where the discharge flow rate is high

Overall dimensions (mm)

MSL/MSV



SV

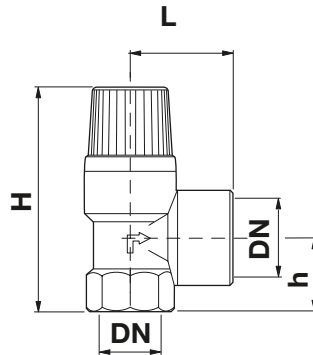

DN	L	H	h
1/2" x 3/4"	34	72,7	24,5
3/4" x 1"	37	84,2	34
1" x 1.1/4"	55	189	40
1.1/4" x 1.1/2"	60	204	43

IS

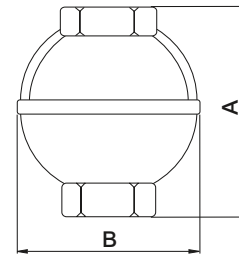

DN	A	B
1/2"	61	45
3/4"	65	57
1"	78	68
1.1/4"	113	97

Specification text

MSL series

Diaphragm safety valve **MSL Series** – WATTS brand – with pressure setting from 1.5 to 10 bar. CW617N brass body. Technopolymer manual discharge knob. Ni-Cr steel spring. Operating temperature range: -10 to 110°C. With added glycol: 50% 1/2" MF connections WRAS approved. Compliant with 2014/68/EU Identification number CE0425.

MSV series

Diaphragm safety valve **MSV Series** – WATTS brand – with pressure setting from 1 to 10 bar. CW617N brass body. Technopolymer manual discharge knob. Ni-Cr steel spring. Operating temperature range: -10 to 110°C. With added glycol: 50% 1/2" FF connections WRAS approved. Compliant with 2014/68/EU Identification number CE0425.

SV series

Diaphragm safety valve **SV Series** – WATTS brand – with pressure setting from 1.5 to 10 bar. CW617N brass body. Technopolymer manual discharge knob. Ni-Cr steel spring. Rubber diaphragm and seal resistant to 110°C. 1/2" - 1.1/4" FF connections with larger outlet. TÜV approved. Compliant with 2014/68/EU Identification number CE0425.

IS Series

Exposed brass drain funnel **IS Series** – WATTS brand – for safety and thermal drain valves. Diameters from 1/2" to 1 1/4" with FF connections.

The descriptions and photographs contained in this product specification sheet are supplied by way of information only and are not binding.

Watts Industries reserves the right to carry out any technical and design improvements to its products without prior notice. Warranty: All sales and contracts for sale are expressly conditioned on the buyer's assent to Watts terms and conditions found on its website at www.wattswater.eu. Watts hereby objects to any term, different from or additional to Watts terms, contained in any buyer communication in any form, unless agreed to in a writing signed by an officer of Watts.

WATTS[®]



Watts Industries Italia S.r.l.

Via Brenno, 21 • 20853 Biassono (MB) • Italy
Tel. +39 039 4986.1 • Fax +39 039 4986.222
infowattsitalia@wattswater.com • www.watts.com