



ExMax ¼ turn actuators – size M

Electrical, explosion proof rotary actuators

On-off / 3-pos. control mode, 24...240 VAC/DC, 95° angle of rotation incl. 5° pretension

50 / 75 – 100 – 150 Nm without and 30 – 50 – 60 Nm with safety operation (spring return)

ATEX tested in acc. with directive 2014/34/EU for zone 1, 2, 21, 22

ExMax - ...
ExMax - ... - F
ExMax - ... - S
ExMax - ... - SF
ExMax - ... - CTM
ExMax - ... - VAM

Subject to change!

Compact. Easy installation. Universal. Cost effective. Safe.

Type	Torque	Supply	Motor running time	Spring return	Control mode	Feedback	Wiring diagram
ExMax- 50.75	50 / 75 Nm	24...240 VAC/DC	40 / 60 / 90 / 120 / 150 s/90°	–	On-off, 3-pos.	–	SB 1.0
ExMax- 100	100 Nm	24...240 VAC/DC	40 / 60 / 90 / 120 / 150 s/90°	–	On-off, 3-pos.	–	SB 1.0
ExMax- 150	150 Nm	24...240 VAC/DC	40 / 60 / 90 / 120 s/90°	–	On-off, 3-pos.	–	SB 1.0
ExMax- 30 - F	30 Nm	24...240 VAC/DC	40 / 60 / 90 / 120 / 150 s/90°	~ 20 s/90°	On-off, 3-pos.	–	SB 2.2/2.3
ExMax- 50 - F	50 Nm	24...240 VAC/DC	40 / 60 / 90 / 120 / 150 s/90°	~ 20 s/90°	On-off, 3-pos.	–	SB 2.2/2.3
ExMax- 60 - F	60 Nm	24...240 VAC/DC	40 / 60 / 90 / 120 s/90°	~ 20 s/90°	On-off, 3-pos.	–	SB 2.2/2.3
ExMax- ... - S/SF	Types as above with 2 integrated, potential free auxiliary switches, 5° and 85° angle of rotation					2 × aux. switches	SB 3.0
ExMax- ... - CTM	Types as above with aluminium housing and seawater resistant coating (cable glands brass nickel-plated)						
ExMax- ... - VAM	Types as above with stainless steel housing for aggressive ambient (cable glands brass nickel-plated)						

Product views and applications

Safety damper



Ball valve

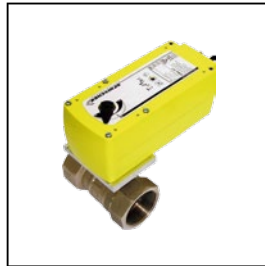

Throttle valve

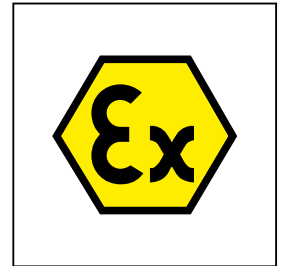

Description

The ExMax actuators are a revolution for safety, control and shut-off dampers, ball valves, throttle valves and other motorized applications for HVAC systems in chemical, pharmaceutical, industrial and offshore/onshore plants, for use in Ex-areas zone 1, 2 (gas) and zone 21, 22 (dust).

Highest protection class (ATEX) and IP67 protection, small dimensions, only 9,5 kg weight, universal functions and technical data, an integrated heater and an optional stainless steel housing guarantee safe operation even under difficult environmental conditions. High quality brushless motors guarantee long life.

All actuators are programmable and adjustable on site. Special tools or equipment are not required. Motor running times and torques are selectable or adjustable on site. The integrated universal power supply is self adaptable to input voltages in the range of 24...240 VAC/DC. The actuators are 100 % overload protected.

...Max...F actuators are equipped with spring return fail safe function. Standard shaft connection is a double square direct coupling with 16 × 16 mm.

Different accessories are available to adapt auxiliary switches, terminal boxes or adaptations for ball valves and throttle valves and other armatures.

Highlights

- ▶ For all types of gases, mists, vapours and dusts in zones 1, 2, 21 and 22
- ▶ Universal supply unit from 24...240 VAC/DC
- ▶ Different motor running times 40–60–90–120–150 s/90°, adjustable on site
- ▶ Spring return running time ~ 20 s/90°
- ▶ On-off and 3-pos. control with or without spring return function
- ▶ 30–50–60–75–100–150 Nm actuators in the same housing size
- ▶ 100 % overload protected
- ▶ Compact design and small dimension (L × W × H ~ 288 × 149 × 116 mm)
- ▶ Direct coupling to the damper shaft with double square connection 16 × 16 mm
- ▶ 95° angle of rotation inclusive 5° pretension
- ▶ Robust aluminium housing (optional with seawater resistant coating) or in stainless steel
- ▶ IP67 protection
- ▶ Simple manual override included + preparation for comfortable manual override
- ▶ Gear made of stainless steel and sinter metal
- ▶ Weight only ~ 9,5 kg
- ▶ Integrated heater for ambient temperatures down to –40 °C
- ▶ Integrated safety temperature sensor
- ▶ Integrated equipment for manual adjustment (push button, lamp, switch)
- ▶ Preparation for adaptable and adjustable auxiliary switches type ...Switch
- ▶ Wide range of accessories



ExMax-...

ExMax-...-F

ExMax-...-S

ExMax-...-SF

SCHISCHEK
EXPLOSIONPROOF

Special option

... -CTM

... -VAM

Technical data	ExMax- 50.75	ExMax- 100	ExMax- 150	ExMax- 30 -F	ExMax- 50 -F	ExMax- 60 -F
Torque motor (min.)	50 / 75 Nm selectable	100 Nm	150 Nm	30 Nm	50 Nm	60 Nm
Torque spring (F)	–	–	–	min. 30 Nm	min. 50 Nm	min. 60 Nm
Torque blockade	In blockade and end positions torques are higher than above specified torques for motor and spring.					
Dimensioning of external load	Upon spring return the external load should be max. 80 % of torque spring (F), but min. 10 Nm					
Supply voltage / frequency	24...240 VAC/DC ± 10 %, self adaptable, frequency 50...60 Hz ± 20 %					
Power consumption	max. starting currents see ① Extra information (in acc. with voltage, $I_{start} \gg I_{rated}$), approx. 5 W holding power, approx. 16 W for heater					
Protection class	Class I (grounded)					
Angle of rotation and indication	95° incl. ~ 5° pretension, mechanical value indication					
Working direction	Selectable by left/right mounting to the damper/valve shaft					
Motor running times [s/90°]	40/60/90/120/150	40/60/90/120/150	40/60/90/120	40/60/90/120/150	40/60/90/120/150	40/60/90/120
Motor	Brushless DC motor					
Control mode	On-off and 3-pos. in acc. with wiring, selectable on site					
Spring return (F)	–	–	–	spring return upon voltage interruption		
Spring return response time	–	–	–	up to 1 sec. after voltage interruption		
Spring return running time (F)	–	–	–	~ 20 s/90°		
Safety operations at 20 sec. (F)	–	–	–	min. 10,000 acc. to construction of damper and ambient		
Auxiliary switches	...-S, ...-SF 2 integrated auxiliary switches, switching at 5° and 85° angle of rotation, potential free. Grid fuse-protection is recommended!					
	$U_{max}/I_{max} AC = 250 V/5 A$; $U_{min} AC/DC = 5 V$; After one-time operation with $U > 24 V AC/DC$ or $I > 100 mA$: $U_{min} AC/DC = 12 V$ $U_{max}/I_{max} DC = 48 V/1 A$; $I_{min} AC/DC = 5 mA$; $I_{min} AC/DC = 100 mA$					
Axle of the actuator	Double square 16 × 16 mm, direct coupling, 100 % overload protected					
Electrical connection	Cable ~ 1 m, wire cross section 0.5 mm ² , equipotential bonding 4 mm ² . Connections in hazardous areas require an Ex-e terminal box!					
Diameter of cable	~ Ø 7.1 mm	~ Ø 7.1 mm	~ Ø 7.1 mm	~ Ø 7.4 mm	~ Ø 7.4 mm	~ Ø 7.4 mm
	2 cables in the versions ...-S and ...-SF (~ Ø ... + 7.4 mm)					
Cable gland	M16 × 1.5 mm					
Manual override	Use delivered socket wrench, max. 4 Nm					
Heater	Integrated, controlled heater for ambient temperature down to -40 °C					
Housing material	Aluminium die-cast housing, coated. Optional with seawater resistant coating (...-CTM) or stainless steel housing, № 1.4581 / UNS - J92900 / similar AISI 316Nb (...-VAM)					
Dimensions (L × W × H)	~ 288 × 149 × 116 mm, for diagrams see ① Extra information					
Weight	~ 9.5 kg aluminium housing, stainless steel ~ 15 kg					
Ambients	Storage temperature -40...+70 °C, working temperature -40...+40 °C at T6 and -40...+50 °C at T5					
Humidity	0...90 % rH, non condensing					
Operation mode	80 % of ED are permitted (ED = duty cycle)					
Maintenance	Maintenance free relative to function, maintenance must comply with regional standards, rules and regulations					
Wiring diagrams	SB 1.0	SB 1.0	SB 1.0	SB 2.2 / 2.3	SB 2.2 / 2.3	SB 2.2 / 2.3
Scope of delivery	Actuator, 4 screws M8 × 140 mm, 4 nuts M8, Allen key for simple manual override					
Parameter at delivery	50 Nm, 90 s/90°	100 Nm, 90 s/90°	150 Nm, 90 s/90°	30 Nm, 90 s/90°	50 Nm, 90 s/90°	60 Nm, 90 s/90°

Approbations

ATEX Directive	2014/34/EU
EU-Type Examination	EPS 17 ATEX 1 132 X
IECEX Conformity	IECEX EPS 17.0065X
Marking Gases	II 2 (2) G Ex db [ib Gb] IIC T6, T5 Gb
Types ...-CTM	II 2 (2) G Ex db [ib Gb] IIB T6, T5 Gb
Marking Dusts	II 2 (2) D Ex tb [ib Db] IIIC T80°C, T95°C Db
CE Marking	CE 0158
EMC Directive	2014/30/EU
Low Voltage Directive	2014/35/EU
Enclosure Protection	IP67 in acc. with EN 60529

Special solutions and accessories

...-CTM	Types in aluminium housing with seawater resistant coating, parts nickel-plated
...-VAM	Types in stainless steel housing, parts nickel-plated
ExBox-...	Ex-e terminal boxes for zone 1, 2, 21, 22
MKK-M	Mounting bracket for boxes type ...Box-... directly on actuator
ExSwitch	2 external aux. switches, adjustable for zone 1, 2, 21, 22
HV-MK	Comfortable manual override for ...Max actuators size M
AR-16-xx	Reduction part for 16 mm square connection to 14 or 12 mm shafts
Kit-S8	Cable glands nickel-plated
Adaptions	for dampers and valves on request
ExMax-...-S3	Ambient temperature up to +60 °C (T4), 110...240 VAC/DC, 25 % ED

ExMax-M-3P_en
V04 - 14-Jan-2019



ExMax-...

ExMax-...-F

ExMax-...-S

ExMax-...-SF



Special option

... -CTM

... -VAM

Electrical connection

All actuators are equipped with a universal supply unit working at a voltage range from 24...240 VAC/DC. The supply unit is self adjusting to the connected voltage!
 The safety operation of the spring return function works if the supply voltage is cut.
 For electrical connection inside hazardous areas an Ex-e terminal box, certificated in acc. with ATEX is required (e.g. ExBox).
 An over-current protection fuse < 10 A has to be provided by installer.
 Note: the initial current is appr. 2 A for 1 second.
 Integrated auxiliary switches signal the rotation angle's position. U_{min} and I_{min} change once the switches were operated with higher voltage or current.

Wiring diagram ExMax- ... (without spring return)

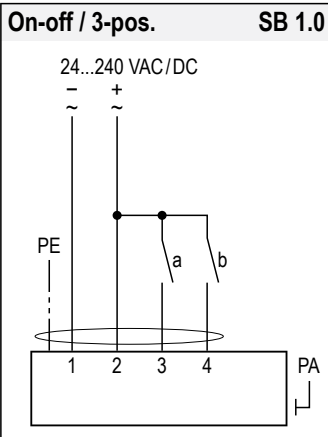

Attention

During commissioning apply a self adjustment drive.

Regard duty cycle at motor running times!

Never use spring return actuators without external load.

Wiring diagram ExMax- ... -F (with spring return)

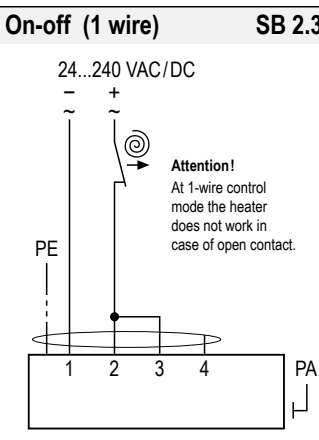
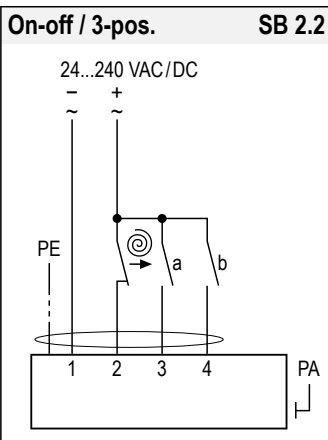

Wiring diagram ExMax- ... -S and ... -SF

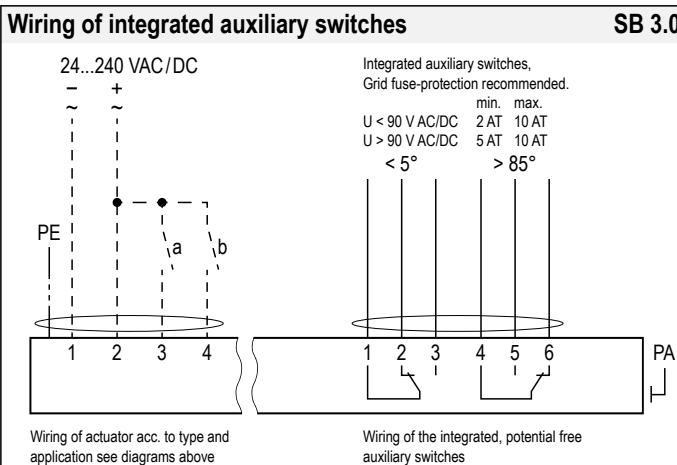

Parameters, adjustments and failure indication

Switch – Push button – Lamp for adjustment (behind the blanking plug)

10-position switch (S)
 Push button (T)
 3-colour LED

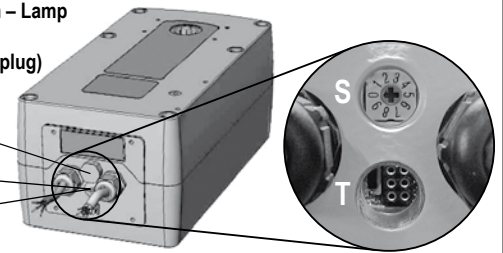

Parameter selection

Example:
 ExMax-50.75

Requested parameter:
 Torque 75 Nm
 Motor running time 90 s/90°

Result:
 Switch position 07

Type	Torques	
ExMax- 50.75	▶ 50 Nm	75 Nm
ExMax- 100	▶ 100 Nm	
ExMax- 150	▶ 150 Nm	
ExMax- 30 -F	▶ 30 Nm	
ExMax- 50 -F	▶ 50 Nm	
ExMax- 60 -F	▶ 60 Nm	

Running times	Position of switch (S)	
40 s/90°	▶ 00	05
60 s/90°	▶ 01	06
90 s/90°	▶ 02	07
120 s/90°	▶ 03	08
150 s/90°	▶ 04	09

Functions, adjustments and parameters

A) Self adjustment of angle of rotation

Turn switch (S) to position 02 (low torque) or 07 (high torque). Press button (T) for a minimum of 3 seconds. The actuator drives to both end positions and detects the blocking positions. The LED flashes GREEN during adjustment. The adjustment takes about 180 seconds (90 sec. "On", 90 sec. "Off").

B) Selecting motor running time and torque

Adjust parameters only if actuator is in idle state or without applied potential. Turn switch (S) to the position required for the intended operation acc. to table above. The selected parameters will be carried out at the actuator's next operation.

C) Additional information for control in 3-pos. operation

a closed, b open = direction I a and b closed = motor doesn't work
 b closed, a open = direction II a and b open = motor doesn't work
 The rotation direction (I and II) depends on left/right mounting of the actuator to the damper. To reverse the rotation direction (by motor) exchange the electrical wiring of terminal 3 and 4.

Installation

Ex area – zone 1, 2, 21, 22



Safe area



Auxiliary switches * see Technical data

Supply * 24...240 VAC/DC ± 10 %

* electrical wiring see diagrams

- Do not open the cover when circuits are live
- Connect potential earth
- Close all openings to ensure enclosure protection
- Clean only with damp cloth, avoid dust accumulation



ExMax-...

ExMax-...-F

ExMax-...-S

ExMax-...-SF

SCHISCHEK
EXPLOSIONPROOF

Special option

... -CTM

... -VAM

Important information for installation and operation**A. Installation, commissioning, maintenance**

All national and international standards, rules and regulations for hazardous Ex-areas must be complied with. Certified apparatus must be installed in accordance with manufacturer instructions. If the equipment is used in a manner not specified by the manufacturer, the safety protection provided by the equipment may be impaired. For electrical installations design, selection and erection, EN/IEC 60079-14 can be used.

For electrical connection an Ex-e terminal box is required (e.g. ExBox-...).

Attention: If the actuator is put out of operation all Ex rules and regulations must be applied. You have to cut the supply voltage before opening the terminal box!

The cables of the actuator must be installed in a fixed position and protected against mechanical and thermal damage. Connect potential earth. Avoid temperature transfer from armature to actuator! Close all openings with min. IP67.

For outdoor installation a protective weather shield against sun, rain and snow should be applied to the actuator as well as a constant supply at terminal 1 and 2 for the integrated heater. During commissioning apply a self adjustment drive.

Actuators are maintenance free. An annual inspection is recommended. For electrical installations inspection and maintenance, EN/IEC 60079-17 can be used. Ex-actuators must not be opened by the customer.

B. Manual override

Manual override only if supply voltage is cut. Use delivered socket wrench with slow motions, usage can be tight.

Attention: Releasing or letting go the Allen key too fast at manual operating actuators with spring return causes risk of injury!

C. Shaft connection, selection of running time

Actuators are equipped with a direct coupling double square shaft connection of 16 x 16 mm. The housing of the actuator is axially symmetrically built to select Open-close direction of the spring return function by left-right mounting. Using the 10-position switch different motor running times and spring return running times can be selected on site in acc. to the actuator type.

D. 3-position control mode

...Max actuators are in the best way suitable for the 3-pos. operation. To protect such elements as gears and mounting elements against harmful influences like minimum pulse time, ...Max actuators are protected via internal electronics. It ignores impulses < 0.5 s, the cyclic duration must be min. 0.5 s. At changing direction the pause is 1 s.

E. Spring return

Spring return function works only if the supply voltage for terminal 1 or 2 is cut. In the event of an electrical interruption, the spring returns to its end position even if supply voltage is available again during return function. Thereafter operation will continue.

F. Operation at ambient temperatures below -20 °C

All actuators are equipped with a regulated integrated heating device designed for employments down to -40 °C ambient temperature. The heater will be supplied automatically by connecting the constant voltage supply on the clamps 1 and 2.

1. After mounting the actuator must be immediately electrically connected.
2. The heater switches on automatically when actuator reaches internally -20 °C. It heats up the actuator to a proper working temperature, then heater switches off automatically. Actuator will not run during heating process.
3. The adjustment options are only ensured after this heating up period.

G. Excess temperatures

In acc. to the ATEX rules and regulations Ex actuators must be protected against excess temperature. The internal thermostat works as a maximum limiter and, in the event of failure at incorrect temperatures, shuts off the actuator irreversible. An upstream connected temperature sensor stops the actuator before reaching its max. temperature. This safety feature is reversible, after cooling down the actuator is completely functional again. In this case the failure must be eliminated immediately on site!

H. Synchron mode

Do not connect several actuators to one shaft or link mechanically together.

I. Mechanical protection

Actuators must be operated with a minimum external load.

After installing the actuator to the damper/armature a self adjustment drive has to be performed in order to protect the damper/armature against mechanical overload. During operation the actuator reduces briefly its speed (motor power) before reaching the end position for a "gentle" blockade/stop.

J. Intrinsically safe circuits

The actuator has a flameproof enclosure acc. to EN 60079. The supply of the push button (adjustment drive), the 10-position switch (adjustment of torque and running time) and the LED indicator is performed intrinsically safe!

K. Loss of voltage

In switch position 00, 01 and 05, 06 (motor running times 40 sec. and 60 sec.) and after interrupted voltage the actuator (types 50.75, 100 and 150 and ...-S) moves in OFF position then the actuators works regarding control signal.

ⓘ Extra information (see additional data sheet)

Additional technical information, dimensions, installation instruction, illustration and failure indication

Accessory ExSwitch – Ex-d auxiliary switch

For an end or inclined position indication it is possible to retrofit external, adjustable, explosion proof auxiliary switches type ExSwitch.

The ...Switch is mounted directly to the actuator. The switches deliver a potential free output and can be adjusted separately. They are connected by cable.

Accessory ExBox – Ex-e terminal box

For electrical connection of the ...Max actuator in a hazardous area an Ex-e terminal box is required.

To adapt the ...Box directly to the actuator housing a mounting bracket is required.

ExBox- 3P for ...Max-... and ...Max-...-F

ExBox- Y/S for ...Max-...-S and ...-SF