

EN
English

Installation Manual Smile Connect System

Table of contents

1	Security Details	4
1.1	Intended use	4
1.2	Electrical installation.....	4
2	System Description	5
2.1	Scope of delivery.....	7
2.2	Accessories.....	7
3	Mounting and Electrical Connection	8
3.1	Requirements.....	8
3.2	Smile Connect.....	8
3.2.1	Mounting.....	8
3.2.2	Electrical connection	11
4	Initial Operation	14
4.1	Configuration with the setup wizard	15
4.2	Extended configurations	27
4.2.1	Generate adjustment protocol	27
4.2.2	Notifications	29
4.2.3	System management	31
4.2.4	Pro = Professional.....	33
4.3	Smile App.....	43
4.3.1	User roles	43
4.3.2	Installation and operation of Smile App	43
5	Software Update	46
6	LED Display Smile Connect	48
7	Help in case of problems	49
7.1	Error messages.....	49
7.2	Loss of acces data	50

8	Technical Data	50
8.1	Smile Connect.....	50

1 Safety Details

1.1 Intended use

- The Smile Connect System is a system that controls all components of a heating system. The Smile Connect System can be operated Smartphone and Tablet.
- The devices are not suitable for children and shall not be used as toys.
- Store packaging materials childproof away or dispose of it.
- Do not disassemble the devices. If malfunctions occur, please inform your installer.

1.2 Electrical installation

The electrical installation, initial operation and servicing of the device must be performed by qualified electrical technicians who have been authorized by the operator. The technicians must have read and understood these operating instructions and follow their procedures. The requirements of a qualified electrical technician are as follows:

- Knowledge of the relevant electrical regulations (e.g. DIN VDE 0100 Part 600, DIN VDE 0100-722) plus the relevant national regulations.
- Knowledge of the general and special safety and accident prevention regulations.
- Ability to identify risks and avoid possible hazards.



CAUTION

Danger of live Parts

Contacting of live electrical parts can result in electrical shocks, in burns or can be leading to death.

Prior to working on electrical systems, follow the following points:

- Unplug device from power
- Protect device against re-powering
- Check that system is not powered

2 System Description

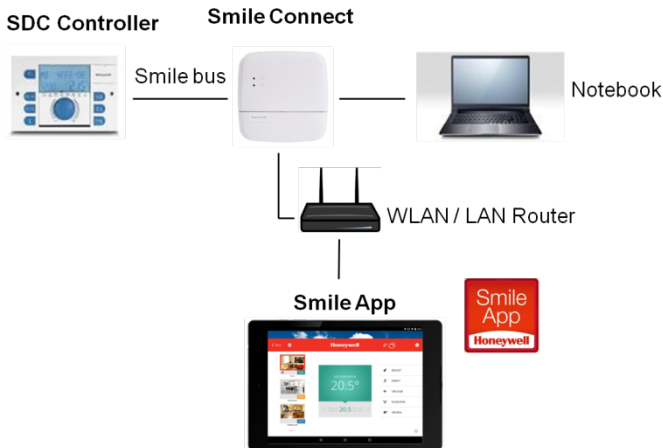

Figure 1: System overview Smile Connect System

The Smile Connect System is a retrofit operable system using iOS- and Android devices for existing SDC controllers. It allows single room control with demand request according to EN 15232 by using a boiler connection.

The basic settings (min-max values, heating curve, heating system, antifreeze protection value, etc.) for the heating circuits must be done under RoomGroups in the menu "Expert" using the Smile App. Based on these set points, the Smile Connect calculates the flow or WW set point and transmits the values to the controller.

Limitations for SDC controller

The software versions of the SDC controller are restricted as follows:

Software version <3.2:

- No controller parameters are adjustable.

Software version <=3.2:

- If supply circuits are controlled via a room sensor at the variable input VE or via the Bus remote operation module SDW10 or SDW30, then these supply circuits cannot be controlled via Smile App. In order to control the supply circuits via Smile App, the room sensors or the remote controls have to be removed.

The Smile Connect System contains the following components:

SDC Controller

The SDC controller controls the heating system in the building.

Smile Connect

The Smile Connect unit is the control center of the system. It can communicate with the Smile controller which is managing the heat generators. It transmits the heat demand to the Smile controller. The Smile Connect communicates via Smile Bus with the SDC controller.

Smile App

The Smile App is installed on mobile devices like Smartphones or Tablets (iOS or Android) and provides the operation of the Smile Connect System.

WLAN / LAN Router (provided by customer)

The WLAN / LAN Router of the customer provides the operation and communication with the SDC controller and with the Smile Connect via Smile App.

2.1 Scope of delivery

Check the contents of the cardboard box. The following components are included:

- Smile Connect (1x)
- Power cable with Schuko plug (two-pin earthed) for Smile Connect (1x)
- Power cable for Smile Connect
- Mounting material
- Operation manual

2.2 Accessories

The following components are deliverable as accessories:

- Installation kit SCI-10 including USB-LAN adaptor and Ethernet cable
- SCW-10 WLAN stick

3 Mounting and Electrical Connection

3.1 Requirements

The operation of the Smile Connect System requires an Ethernet network (LAN / WLAN) including a router.

For the initial operation of the Smile Connect System, a standard laptop plus the installation kit SCI-10 is needed.

3.2 Smile Connect

3.2.1 Mounting

Find a suitable mounting place on the wall for the **Smile Connect**, which fulfills the following requirements:

- At the mounting place of the **Smile Connect** a 230 V connection must be provided.
- The mounting place of the **Smile Connect** must be near the SDC controller and must not exceed 50 meters. If **Smile Connect** must use a connection to the heat generator (0-10 V) then the distance should also be max. 50 meters.
- At the mounting place of the **Smile Connect**, a LAN connection to the home network of the customer must be available.

Or, alternatively

- The mounting place must be within reach of the customer's WLAN network in order to use the **SCW-10 WLAN stick***.

* The **SCW10 WLAN stick** is not included in the standard scope of delivery and must be ordered separately as accessory.

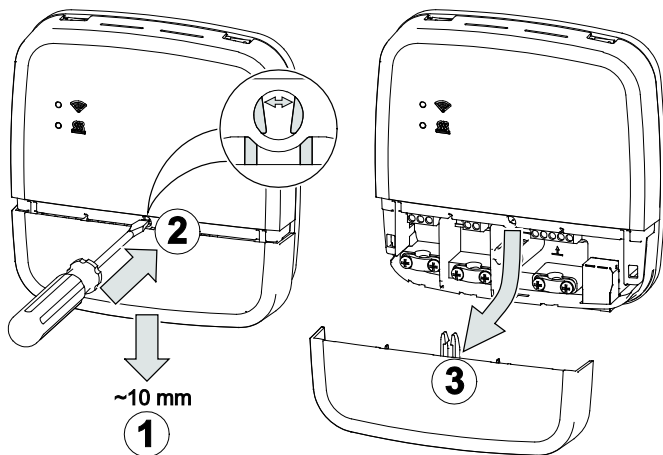

Figure 2: Open housing

1. Move down the terminal cover approx. 1 cm until the end stop.
2. With a screwdriver, carefully push apart the interlock of the terminal cover. To avoid damage of the electronic, do not insert the screwdriver too deeply.
3. Pull down the terminal cover.

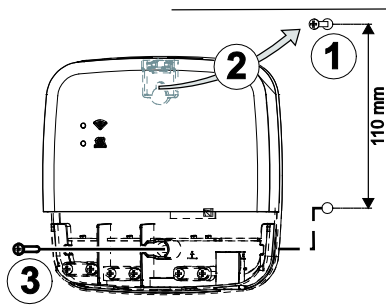

Figure 3: Wall mounting

4. Install Smile Connect with the provided mounting material on the selected assembly site (Figure 3, 1 - 3).

3.2.2 Electrical connection

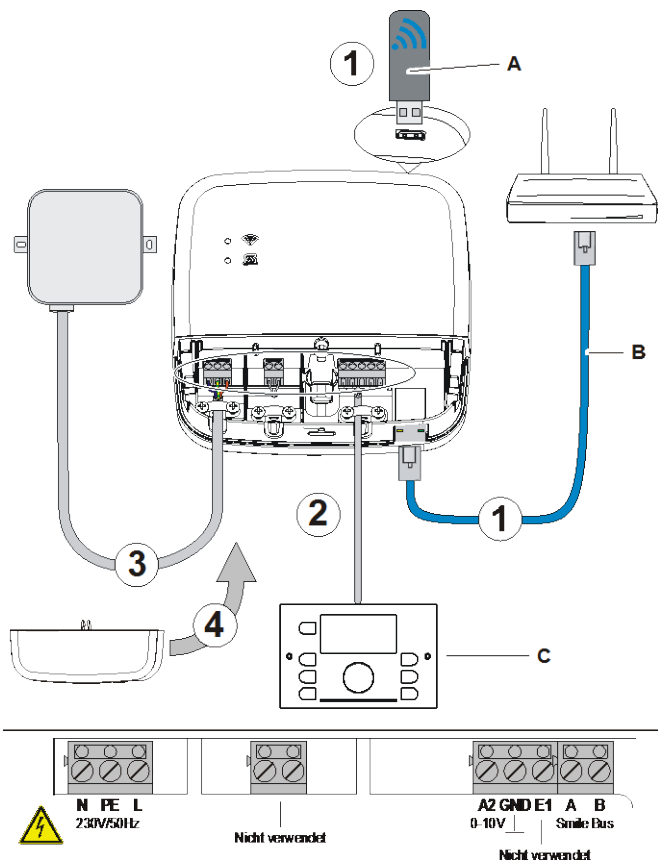

Figure 4: Electrical connection Smile Connect

**CAUTION****Danger of live parts**

Contacting of live electrical parts can result in electrical shocks, in burns or can be leading to death.

Prior to working on electrical systems, follow the following points:

- Unplug device from power
- Protect device against re-powering
- Check that system is not powered

1. Connect the **Smile Connect** to the home network of the customer as follows:

- via a network cable (B) with free Ethernet port of the internet router or switch. The length of the total cable distance from the **Smile Connect** to the next switch or router may only have a maximum of 100 meters.
- Or, via WLAN connection. Therefore, insert the **SCW10 WLAN stick*** (A) in one of the USB sockets on the upper side of the **Smile Connect**.

For the proper function of the **Smile Connect**, the WLAN stick must be inserted permanently.

Ask the customer for the access data of his/her WLAN network – you will need the data for the following operating steps.

In addition, point out to the customer that from now on changes on his/her WLAN (new router, other keys etc.) can impair the function of the Smile Connect System and may result in a new adaptation of the Smile Connect System.

2. Connect the heat generator to the **Smile Connect** according to the terminal configuration.

* The **SCW10 WLAN stick** is not included in the standard scope of delivery and must be ordered separately as accessory.

- **Smile Bus and SCD controller applied:**
Connect the SDC controller to the terminals A, B at the **Smile Connect** and later using the setup wizard , select the option „*Controller (Smile bus)*“ in the area „*Heat generator*“.
 - **Control signal 0-10 V and 3rd party controllers applied:**
The **Smile Connect** converts the supply temperature value or the heat generator power into an output signal 0-10 V (=0 – 100 °C). The corresponding parameter setting will be done in the "Expert" mode of the **Smile Connect** menu (Browser, Tablet and Smartphone).
Connect the control signal input (0-10 V) of the heat generator to terminals A2 / GND and later using the setup wizard, select the option „*Energy generator control signal 0-10V (A2)*“ in the area „*Heat generator*“.
 - Input E1 is not used
3. Connect the **Smile Connect** to the electrical supply network according to the terminal configuration.
 4. Replace the terminal cover.

4 Initial Operation

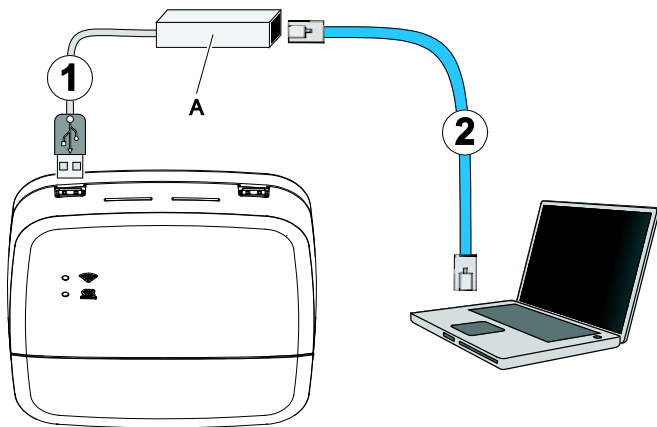

Figure 5: Initial setup Smile Connect

The initial operation contains the configuration of the Smile Connect via browser (e.g. IE, Chrome and Firefox) using the connected PC / Laptop.



Before you start the initial operation, please select the following LAN options in the local network settings of the browser:

- Enable **DHCP (Dynamic host configuration protocol)**
- Disable all **Proxy server** options.

► NOTE

A later update of the device software via internet download, can result in additional costs dependent on the internet rate of the customer.

4.1 Configuration using the Setup Wizard

1. Insert the **USB-LAN adaptor SCI-10 (A)** in a free USB port on the upper side of the **Smile Connect**.
2. Connect the **USB-LAN adaptor SCI-10** via Ethernet cable to the network connection of the PCs / Laptops.
3. Switch on the PC / Laptop and open the browser.
4. The setup wizard will then start automatically in the browser.
5. If the setup wizard is not starting automatically, please enter the address <http://10.0.0.1> in the address line of the browser.
6. Connect the WLAN stick/ LAN adaptor to the internet if you want to execute a software update at initial setup (see chap. 5, "Software Update")
7. Follow the instructions of the setup wizard by clicking on the red push buttons (arrow forward , arrow backward ) and select the settings in the menus.



Welcome to the initial setup

The initial setup guides you through the menus to adjust the system. Please start by pressing the arrow button on the right side.



The individual configuration steps are described as follows.

Network

The currently possible connections are highlighted in green. In case, no connection should be possible, please check the physical connection between SCN-10 and the router.



1. To select a network connection, click on the plus symbol of the desired network connection and select the specific settings for the selected network:

Network connection via LAN

The LAN network can be configured automatically (preset) or manually by entering the IP address, network mask, standard gateway and DNS server data.

Network connection via WLAN

2. Insert the SCW-10 WLAN stick in the USB port of the SCN-10.

Proxy configuration

3. Enter the URL of the Proxy server.
4. Click on **Apply network configuration**. Enter the password at request.

Remote access

5. To operate your heating system externally via the internet, click on the button **Connection to remote access**.
6. Click on .

If remote access is not possible or selected, a message will appear.

Your Smile Connect SCN-10 is currently not connected to Remote connect. It will not be possible to access your heating system from remote. Do you want to continue anyway?



Yes, continue without Remote



Cancel

7. Click on **Yes continue without remote access.**

Heat generator

energy generator

1	energy generator controller (Smile BUS)	✓
2	Domestic hot water controller (Smile BUS)	✓

8. Click on Energy generator
9. Select the type "Controller Smile bus" or "Energy generator control signal 0-10 V A2" and enter a name (optional).

energy generator

1 **energy generator**
select

Choose the type of the connected heat generator. Optional you can change the name.

type

controller (Smile BUS) ▼

name

Gasboiler

ok

10. Click on **OK**.
The mask **Domestic hot water controller** will appear if the WW function is enabled in the controller.

please select the function for domestic hot water.

Domestic hot water

controller (Smile BUS) ▼

name

DHW tank

ok

11. Select the type and enter a name.

12. Click on **OK**.

The mask **Singel room heat regulation** will appear.

3 **Single room heat regulation**
Here you can configure the individual room control.

Turn off the individual room control when gateway is not use.

Single room heat regulation

passive ▼

ok

13. Select **On** and then click **OK**.

The menu **Rooms** is displayed.

► **NOTE**

You can only use the single room heat regulation if a room connect gateway is used in the system

Rooms

room mapping

Register the rooms, which are about to be controlled with Smile Connect SCN-10

1 Create a new heating zone



14. Click on the plus symbol to create a new room.

room mapping

Register the rooms, which are about to be controlled with Smile Connect SCN-10

1 Create a new heating zone

Please set a default name for the room, e.g. children's room. You can individualize room names in the app. If the heat source ist connected please allocate it to the room.

room name

living zone

room supply

controller GEN

controller GEN

controller HC

controller MC1

none

15. Enter a room name, e.g. "Underfloor heating ground floor" and select the hydraulic circuit in the supply circuit which is assigned to the room e.g. "Controller mixed circuit 1".

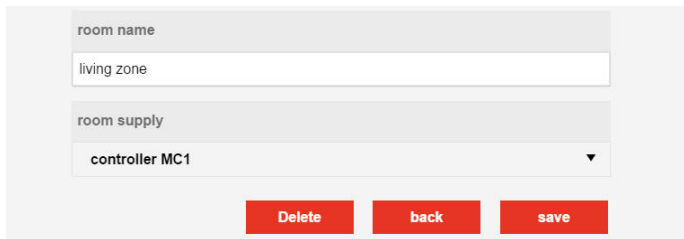

room name

living zone

room supply

controller MC1

Delete back save

16. Click on **Save**.

The mask **Rooms** will appear, in which you can create more rooms.

room mapping

Register the rooms, which are about to be controlled with Smile Connect SCN-10

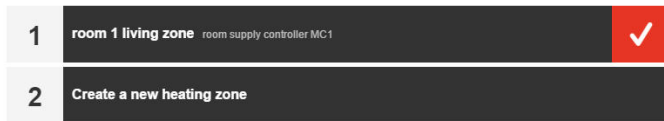

1 room 1 living zone room supply controller MC1 ✓

2 Create a new heating zone

17. Click on .

The menu **My facility** is displayed.

My Heating System

name heating system

What is the name of the heating system?

name heating system:	<input type="text"/>
plant location:	<input type="text"/>

18. Enter a name and the location.

name heating system

What is the name of the heating system?

name heating system:	Smile Demo system
plant location:	London

19. Click on  .
The menu **User** is displayed.

User

Please create a new user. ✕

user role: Please choose ▼	user name: <input type="text"/>
title: Mr. ▼	password: <input type="text"/>
first name: <input type="text"/>	Repeat your password: <input type="text"/>
name: <input type="text"/>	

create



20. To create a new user, click on **Please create a new user**.

The mask *User* will appear.

A minimum of 2 users must be created, one user with the user role "Expert" and one user with user role "Owner".

21. Enter the user data.

Please create a new user. ✕

user role: Expert ▼	user name: Installer
title: Mr. ▼	password:
first name: Peter	Repeat your password:
name: Smith	

create

22. Click on **Create**.

After the creation, the users are shown in a list.

[+ Please create a new user.](#)

1	installer Mr. Thomas Smith user role: Expert	➤
2	owner Mr. Jim Smith user role: owner	➤

23. Click on .

The menu **Date / Time** is displayed

Date / Time

date / time

system time:

12.02.2016 10:27 (Europe/Berlin)

time zone:

Europe/Berlin ▼

time synchronisation

- automatic Internet synchronisation
- automatic time sync with your own NTP server.
- manual time setting

The time and date will be synced automatically with the standard time servers through the internet connection.

save

24. Select the options. We recommend to select the automatic internet synchronisation.
25. Click on **Save**.
The configuration is completed.

Network: > energy generator > rooms > name heating system > user > date / time

Done

You finished the Smile Connect SCN-10 setup successfully. Click here to continue.

menu

26. Click on **Menu** to get to the main menu. In the main menu you can do more settings (e.g. for email notifications and system management).



My Smile Connect
SCN-10



Room Connect



System configuration
document



Network



date / time



Notifications



Setup Wizard



System
management



Expert

After successful configuration, the upper LED „Network“ of the **Smile Connect** is lighting permanently in GREEN indicating that the **Smile Connect** is connected to the customer network and to the internet.

For the meaning of other conditions and advices for the correction of defects, please find in chapter 6 "LED Display Smile Connect".

Remove the **USB-LAN adaptor SCI-10** from the USB port of the **Smile Connect**.

4.2 Extended configurations

After completion of the configuration of the basic functions, you can configure the following optional functions:

- System configuration document
- Notifications
- System management
- Expert

4.2.1 Generate System configuration document

The system configuration document contains all configuration data of the Smile Connect system and can be forwarded via email.

1. Click in the Honeywell main menu on the icon . System configuration document

The mask System configuration document will appear.

System configuration document

The configuration document allows you to centrally open many relevant system parameters in a file and save it.

Show configuration document

 Generate a new configuration document

2. Click on the button **Generate new System configuration document**.

The new System configuration document is generated and saved as PDF file in the **Smile Connect** until a new document is generated. This will take some time so do not interrupt the process.

The new System configuration document shows up in the browser. Scroll through the protocol to look at the data as needed.

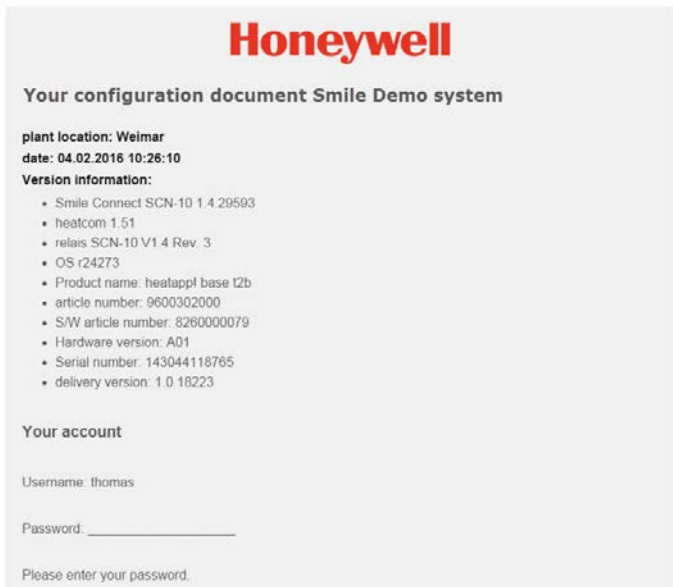

Honeywell

Your configuration document Smile Demo system

plant location: Weimar
date: 04.02.2016 10:26:10

Version information:

- Smile Connect SCN-10 1.4.20593
- heatcom 1.51
- relais SCN-10 V1.4 Rev. 3
- OS r24273
- Product name: heatappl base t2b
- article number: 9600302000
- S/W article number: 8260000079
- Hardware version: A01
- Serial number: 143044118765
- delivery version: 1.0.18223

Your account

Username: thomas

Password: _____

Please enter your password.

3. To print out the new System configuration document , click on the button **Send new System configuration document**

Send PDF via e-mail

Note: For this functionality Remotet must be enabled. Please click [here](#) to get to the network settings. There you can enable Remote.

4. Enable the remote access if not done yet.
5. Navigate back to the main menu via button  and create one or more email addresses as described under " " .
6. Navigate again to this mask.
7. Tap on the button **Send adjustment protocol**.
8. A message will appear if the System configuration document was successfully sent out.

At any time you can go back to the latest generated System configuration document by clicking on the button **Display System configuration document** or by sending a PDF file via email.

9. Via push button  you get back into the main menu.

4.2.2 Notifications

The Smile Connect System sends out push- and email messages in case of interruptions or maintenance notifications.

Push messages are system notifications, which the Smile Connect sends directly to the operating interface of the device (Smartphone / Tablet) so that the user is informed immediately. This can be a malfunction information or maintenance notifications.

Push messages can also be sent to pre-defined and saved email addresses. In addition, the system configuration document can be sent to this email address.

10. Click on the system configuration document icon  in the Honeywell main menu.

The mask **Notifications** will appear.

Note: For this functionality Remote must be enabled. Please click [here](#) to get to the network settings. There you can enable Remote.

Mail notifications

Here you can specify e-mail addresses, to which error messages, notifications and other information is sent.



Add a new e-mail address

Save e-mail addresses

User accounts

Here you can select users that should receive a push notification.

Thomas Smith

Jim Smith

Save user accounts

1. Tap on the button **Add new email addresses**.
2. Enter the email address(es) to which the setup protocol should be sent.

Mail notifications

Here you can specify e-mail addresses, to which error messages, notifications and other information is sent.

e-mail:



Add a new e-mail address

Save e-mail addresses

- Click on the button **Save email addresses** if you wish to send the notifications always to the inserted email addresses in the future.
- Under user accounts, enable those users that shall receive the notifications.

User accounts

Here you can select users that should receive a push notification.



- Click on the button **Save user accounts** if you want to send notifications always to these users in the future.
- Via the button  you get back into the main menu.

4.2.3 System management

The function **System management** allows the update of the Smile system software and a data backup.

- Click on the system management icon  in the Honeywell main menu.

The mask of the system management appears.

System Update

Update the system here. The Smile Connect System is not accessible until the update has completed.
... please be patient.

No update available. (1.4.29852 ↔ 1.4.29852)

System

System restart

Perform a system restart

Restart system now

Reset

Resets the heating system to its factory defaults. The current configuration will be lost.

reset now

System update

System update shows if a software update is available or not.

► NOTE

Software updates only appear if the **Smile System** is connected to the internet.

System

The button **restart system now** triggers a new start of the stem.

The button **reset now** resets the device to the factory setting.

► NOTE

When executing a reset, all set data will be lost irrecoverably and a new setup is necessary. Please use this possibility only at the relevant request of the Honeywell Support or your expert.

Data saving

By means of an USB stick, you can do a data backup. Hereby, you can transfer the settings of the installation to a new device or bring the system back into the secured status after a reset.

1. Insert an USB stick into a free USB port of the Smile Connect.
2. Under **Save settings**, click the button **OK**. A backup file is saved on the USB stick.
3. If you want to restore a Smile Connect System, which is in factory default state, using saved data on USB stick, you must first execute the setup wizard to re-establish the standard settings.
4. Afterwards insert the USB stick with the data backup file into a free USB port of the Smile Connect.
5. Select the backup file.
6. Click on the button **Refresh**. The selected backup will be transferred to the system.

4.2.4 Expert

The menu "Expert" allows access to the most important parameters of the SCD controllers.

NOTE

Only an expert has access to this menu.

Parameters, which force a reset at the controller are only displayed e.g. Hydraulic code, SDC-DHC switchover, Reset

Beyond that, you have access to all superordinate parameters of the controller.

Room 1-16

- Information:
Display of information of operation type, setpoint and current temperature
- Standard settings:
Selection which temperature for the antifreeze protection mode is used. Here you can also change the standard name of the room.

- **Room Settings:**
Setting of temperature setpoint for comfort, setback and antifreeze protection temperatures as well as for the boost function.
 - **Reset:**
Resets the settings to the defaults for the corresponding room.
7. In the Honeywell main menu, click on the Expert icon .
- The following mask will appear.



8. For selecting a system function, click on the corresponding arrow.

system	>	information	>	operation mode heating mode
hot water DHW tank	>	basic settings	>	state heating
room 1 living zone	>	room settings	>	room setpoint 20.0 °C
energy generator Gasboiler	>	heating mode	>	request 40.0 °C
controller	>	reset	>	flow 42.0 °C
fault message	>			
config	>			

More sub items are displayed, which for their parts more sub items can be displayed. The outline can be differently and depends on the configuration of the controller

System

system	>	emergency room control 20.0 %	>	reset
hot water DHW tank	>	reset off	>	off
room 1 living zone	>			ok
energy generator Gasboiler	>			
controller	>			
fault message	>			
config	>			

Reset resets all settings in the Smile Connect except the network settings.

Domestic hot water

Only the DHW function of controller address 10 is visible.

system	➤	information	➤	operation mode automatic
hot water DHW tank	➤	basic settings	➤	state heating
room 1 living zone	➤	heating mode	➤	setpoint 50.0 °C
energie generator Gasboiler	➤	reset	➤	current 50.5 °C
controller	➤			
fault message	➤			
config	➤			

system	➤	information	➤	name
hot water DHW tank	➤	service	➤	Gasboiler
room 1 living zone	➤	basic settings	➤	ok
energie generator Gasboiler	➤	reset	➤	
controller	➤			
fault message	➤			
config	➤			

Smile App sends the set values.

Room

These settings override the controller adjustments.

system	>	information	>	operation mode heating mode
hot water DHW tank	>	basic settings	>	state heating
room 1 living zone	>	room settings	>	room setpoint 20.0 °C
energie generator Gasboiler	>	heating mode	>	request 40.0 °C
controller	>	reset	>	flow 42.0 °C
fault message	>			
config	>			

The current operation mode is shown.

system	>	information	>	request outside temperature control	>
hot water DHW tank	>	basic settings	>	screed off	>
room group 1 living zone	>	room settings	>	frost protection 3.0 °C	>
energie generator Gasboiler	>	heating mode	>	summer operation mode off	>
controller	>	reset	>	frost protection mode night	>
fault message	>			name living zone	>
config	>				

The maximum temperature (Comfort Hi) and the setback temperature (night) limits the room setpoint value in the Smile App.

Boost, Offset and Eco have effect on the actions, which are executed via Smile App.

system	>	information	>	room maximum 35.0 °C	>
hot water DHW tank	>	basic settings	>	comfort hi 21.0 °C	>
room group 1 living zone	>	room settings	>	comfort lo 20.0 °C	>
energie generator Gasboiler	>	heating mode	>	night 11.5 °C	>
controller	>	reset	>	start optimization off	>
fault message	>			offset fast heating 2.0 K	>
config	>			offset economy -2.0 K	>

The heating curve must be selected under **Heating mode**.

Select the heating system under UFH (Underfloor Heating), RAD (Radiators) and CONV (Convectors).

Reset resets all room group settings. The names are deleted.

Heat generator

Only the energy generator of controller address 10 is visible.

system	>	information	>	state on
hot water DHW tank	>	service	>	energie generator on
room group 1 living zone	>	basic settings	>	heating mode 65.0 °C
energie generator Gasboiler	>	reset	>	current 59.0 °C
controller	>			
fault message	>			
config	>			

system	>	information	>	manual mode
hot water DHW tank	>	service	>	off
room group 1 living zone	>	basic settings	>	ok
energy generator gasboiler	>	reset	>	
controller	>			
fault message	>			
config	>			

Controller

system	>	information	>
hot water DHW tank	>	parameter	>
room group 1 living zone	>		
energy generator Gasboiler	>		
controller	>		
fault message	>		
config	>		

For detailed information about controller information and the parameters, please use the Smile service manual GE2H-0221-GE51.

Controller Information

system	➤	information	➤	OUTSIDE	15.5 °C
hot water DHW tank	➤	parameter	➤	OUT MIN/MAX	15.5 °C
room group 1 living zone	➤			EM-SET	65.0 °C
energie generator Gasboiler	➤			HEAT GENER.	59.0 °C
controller	➤			DHW	50.5 °C
fault message	➤			FLOW MC	42.0 °C
config	➤			ROOMTEMP HC	--
				ROOMTEMP MC	--
				OPER. HOURS	61 h
				NR OF STARTS	3
				HEAT GENER.	ON
				HEATING	
				DHW	ON
				ACTUATOR	
				MC	CLOS
				HEATING	
				MC	OFF

Controller parameters

The parameters appear according to the configuration. Parameter settings which force a controller reset are not possible (Hydraulic code, SDC-DHC change, Bus address, Reset)

information	>	HYDRAULIC HYDR.	>
parameter	>	SYSTEM SYST.	>
		DHW DHW	>
		UNMIXED CIRC HC	>
		MIX. VALVE MC	>
		HEAT GENER. H-GEN	>
		ALARM	>
		SENSOR ADJ.	>
		SERVICE	>

Fault message

system	>	SDC controller reports a fault 08.02.2016 14:10
hot water DHW tank	>	Warning 00.00.0000 00:00
room group 1 living zone	>	ok _ _ _ _ _
energie generator Gasboiler	>	ok _ _ _ _ _
controller	>	ok _ _ _ _ _
fault message	>	ok _ _ _ _ _
config	>	ok _ _ _ _ _
		ok _ _ _ _ _
		ok _ _ _ _ _
		ok _ _ _ _ _
		reset off
	>	

Configuration

Assignment of the heating circuits can be adapted.



4.3 Smile App

4.3.1 User roles

In the **Smile App**, the following user roles are available:

- **User:**
The *User* can control the rooms for which he/she has is authorized. The *User* has access to the settings of "My Profile", "Time Schedules", "Design" and "Trends".
- **Owner:**
The *Owner* can manage all rooms and has access to all settings and to the menu "Smile Connect". The *Owner* has limited rights in the area "Expert".
- **Expert:**
The *Expert* has the same rights as the *Owner*. Beyond that, the *Expert* has access to all settings in the area "Expert" (incl. heating parameters). The *Expert* has no rights for viewing integrated pictures (privacy protection).

4.3.2 Installation and operation of Smile App

You can make the customer familiar to the **Smile Connect System** easily by supporting him/her during the installation of the App on his/her device (Tablet or Smartphone) and accompany the first steps in the App.

1. Show the customer at his/her device how to download the App from the Store and how to install it. Therefore start the App Store on an

- Apple device or start the Play Store on an Android device and search for "**Honeywell Smile!**" Let the customer install the App and confirm all advice notes and rights questions during the installation.
2. Make sure that the end device is connected to the home network of the customer, in which the **Smile Connect** resides. Therefore open the WLAN settings on the Apple iOS devices and the Android devices. Make sure that WLAN is switched on and that the device is connected to the right network.
 3. Show how to start the App and how to register him/her with the user name "Owner" and his/her password. Take a note of the access data for the user "Owner". Hand over the access data to the customer.
 4. On the Home screen, show where to find the system components, room groups and domestic hot water etc. Also, where to read the current temperature and how to change individual setpoint temperatures.
 5. On the Home screen, show the pre-allocated quick actions (e.g. Party, Holidays) and how to operate.
 6. Show how to arrange rooms in room groups. For this go to the area "*Settings / Rooms*" and then click on the symbol (≡) down right. Call up the tutorial with the (?) symbol to get the operation explained to yourself.
 7. Show how to set the time schedules and setpoint temperatures. For this go to the area "*Settings / Time schedules*" and together do a rough pre-adjustment. Call up the tutorial with the (?) symbol to get the operation explained to yourself.
 8. Show how users are generated and together set up another user with normal user rights. Assign the rooms you want to control to the user profile. Therefore go to the area "*Settings / Users*" and click on the symbol (+). Call up the tutorial with the (?) symbol to get the operation explained to yourself.
 9. Show the customer how he can invite set up users to **Smile Connect** for the remote operation of the **Smile Connect System**. If your customer agrees, do this as an example with your expert

user role. Therefore go to the area "*Settings / Users*" and then click on the icon .

10. Show how to work on user profiles, add photos and change passwords. Go to the area "*Settings / My Profile*". Recommend the customer to change his/her password regularly for safety reasons.

5 Software Update

▶ NOTE

Software updates only appear if the **Smile System** is connected to the internet.

1. Connect the WLAN/ LAN adaptor to the internet.
2. Setup the Smile Connect System as described in chapter 4, "Initial Operation".
3. Follow the instructions of the setup wizard.

If a software update is available, the following message appears automatically.



System Update

An update is available. Please go to the [system update page](#) to install the upgrade before the initial setup.

4. Click on **System update page** menue.
The update version will appear.
5. Click on **Execute update**.
All relevant current system settings will be saved.

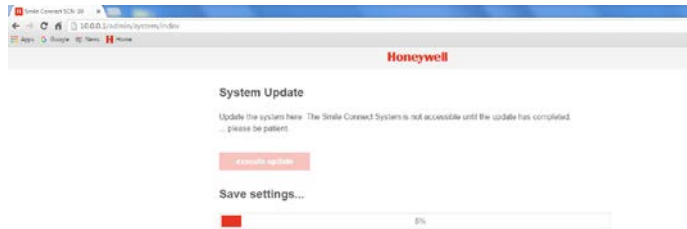

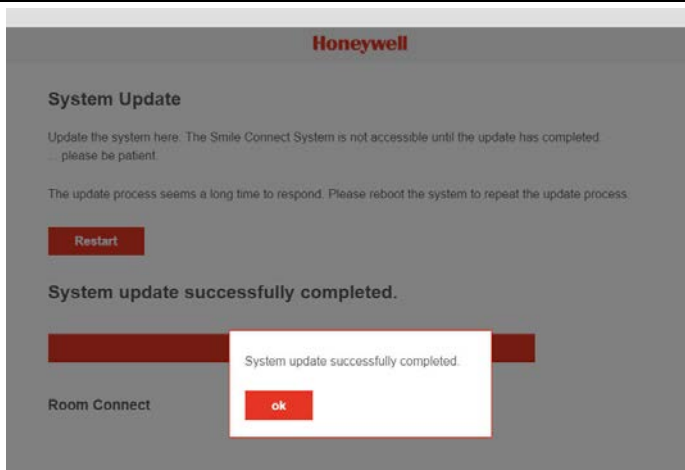

The software is downloaded and installed.



6. Continue by clicking on **OK**.

6 LED Display Smile Connect

LED	 Network	 Control
lights white	Start sequence Step 1 - Power supply on	
lights yellow	Start sequence Step 2 - Start of the operating system	
flashing green	Start sequence Step 3 - Establish network and internet connection	
lights green	Network and internet connection is established	Control is ready for operation
shines yellow	Network connection is established, no internet connection is possible. Verify network configuration!	—
flashing yellow	—	System update or parameter backup saving is executed.
lights red	No network connection is possible.	Disruption in the control, alert messages can be displayed via Smile App
flashing red	System error - update via Internet / USB is necessary.	—
OFF	—	System error - the control continues to work according to the set configuration

7 Help in case of problems

7.1 Error messages

Error message	Reason	Correction
SCN-10 has no connection to the SDC controller	SCN-10 has no connection to the SDC controller	Check the wiring of the Smile Bus
SCN-10 blocked by room sensor or remote control	A room sensor or remote control is assigned to the supply circuit	Disconnect the room sensor or the remote control
Heating circuit in SDC controller is not available	The assigned heating circuit of the SDC controller is no longer available	Check parameter settings of the SDC controller
SCN-10 connected with 3rd party controller	SCN-10 is connected to a 3 rd party controller	Use the Honeywell SDC controller
SDC-10 reports an error	The SDC controller has a malfunction	Under Controller / Parameter / Alert messages, the expert can read out the error code and eliminate this error via the help of the Service Manual

7.2 Loss of access data

If the access data (password, short name) of one of the two users "Expert" or "Owner" were lost or forgotten, then one of those two users can setup again the other user (see chapter Configuration with the setup wizard, page 23) .

If both users "Expert" and "Owner" have lost or forgotten the access data then you can do the following:

1. Create an empty text file with the file name "reset.txt".
2. Save this file on an empty USB stick.
3. Disconnect the **Smile Connect** from the electrical power supply.
4. Insert the USB stick into a free USB port of the **Smile Connect**.
5. Connect the **Smile Connect** to the electrical power supply.

Smile Connect is now set into the factory default status (Reset).

Via the setup wizard in the PC browser, you will have access to the system again. However, all configuration data is lost and you will have to configure the system anew.

8 Technical Data

8.1 Smile Connect

Mounting	Wall mounting
Operating system	Linux
Connections	
<ul style="list-style-type: none"> external 	<ul style="list-style-type: none"> 2 x USB 2.0 RJ45 Ethernet
<ul style="list-style-type: none"> internal (screw terminals) 	<ul style="list-style-type: none"> Supply voltage L/N/PE Smile System Bus 0 ... 10 V output
Power supply	230 V \pm 10 %, 50 Hz, 5 VA
Protection class	II at wall mounting
Protection category	IP 20
Fuse	On Installation Site

Ambience conditions	
• Storage temperature	-25 ... +60 °C
• Operating temperature	-10 ... +50 °C
Dimensions	160 x 160 x 34 mm (LxWxH)
Weight	335 g
Color	Traffic white RAL 9016

Manufactured for and on behalf of the Environmental and Combustion Controls Division of
Honeywell Technologies Sàrl, Rolle, Z.A. La Pièce 16, Switzerland by its Authorized Representative:

Automation and Control Solutions

Honeywell GmbH

Boeblinger Strasse 17

71101 Schoenaich, Germany

Phone +49 (0) 7031 637 01

Fax +49 (0) 7031 637 740

<http://ecc.emea.honeywell.com>

Printed in Germany. All rights and changes reserved.

MU1H-0603GE51 R0216

Art. 0450079519

